

MOBICON

Electronic Components

PRODUCT SPECIFICATION

MEC QUARTZ CRYSTAL

FREQUENCY COMPONENTS

DT38 Series QUARTZ CRYSTAL SPECIFICATION

MOBICON HOLDINGS LTD.		
Prepared By	Sign.	Approved By
Leo Wong		C.H. Wong

www.mobicon.com

MIEC

SPECIFICATION OF CRYSTAL UNIT

PART NO. :

DT38-32.768k12.5100F (H)

ELECTRICAL CHARACTERISTICS

1. Nominal Frequency	32.768 kHz
2. Holder Type	DT 38
3. Frequency Tolerance	± 100 ppm
4. Equivalent Resistance	50k Ohm max.
5. Insulation Resistance	500M Ohm @100V _{DC}
6. Temperature Tolerance	± 50 ppm at $-10 \sim +60^{\circ}\text{C}$
7. Operating Temperature Range	$-10 \sim +60^{\circ}\text{C}$
8. Storage Temperature Range	$-10 \sim +70^{\circ}\text{C}$
9. Loading Capacitance	12.5 pF
10. Drive Level	1 uW max.
11. Aging	± 5 ppm/ year max.
12. Oscillation Mode	Fundamental

DIMENSIONS (mm)

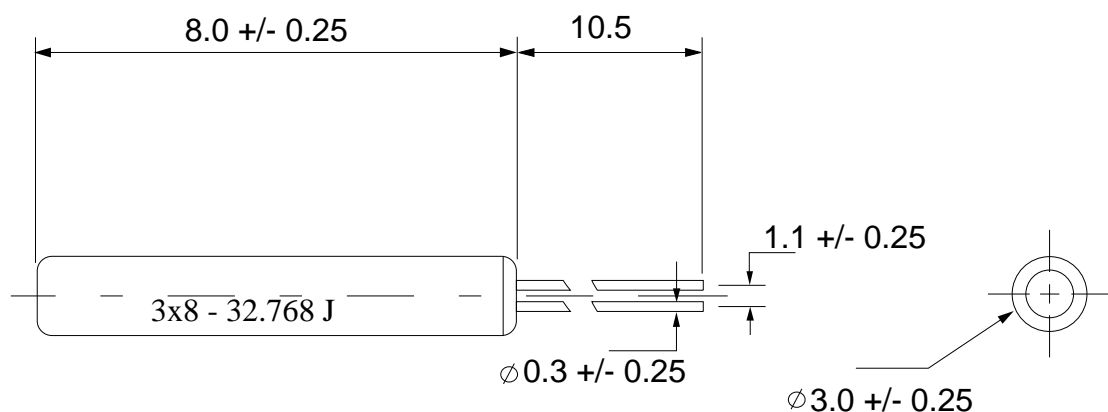

Prepared By: Leo Wong

DOC. No: DT38-32.768kHz12.5pF100ppmF(H)