

MOBICON

Electronic Components

PRODUCT SPECIFICATION

MEC QUARTZ CRYSTAL

FREQUENCY COMPONENTS

DT26 Series QUARTZ CRYSTAL SPECIFICATION

This specifications is subject to change without notice.

MOBICON HOLDINGS LTD.		
Prepared By	Sign.	Approved By
Leo Wong		C.H. Wong

Reprinting and copying of this specifications without prior written permission from MOBICON HOLDINGS LTD are not permitted.

www.mobicon.com

MIEC

SPECIFICATION OF CRYSTAL UNIT

PART NO. :

DT26-32.768k12.520F_30k Ohm

ELECTRICAL CHARACTERISTICS

1. Nominal Frequency	32.768 kHz
2. Holder Type	DT 26
3. Frequency Tolerance	± 20 ppm
4. Equivalent Resistance	30k Ohm max.
5. Insulation Resistance	500M Ohm @100V _{DC}
6. Temperature Tolerance	+/- 50ppm at -10 ~ +60°C
7. Operating Temperature Range	-10 ~ +70°C
8. Storage Temperature Range	-20 ~ +80°C
9. Loading Capacitance	12.5 pF
10. Drive Level	1 uW max.
11. Aging	± 5 ppm/ year max.

DIMENSIONS (mm)

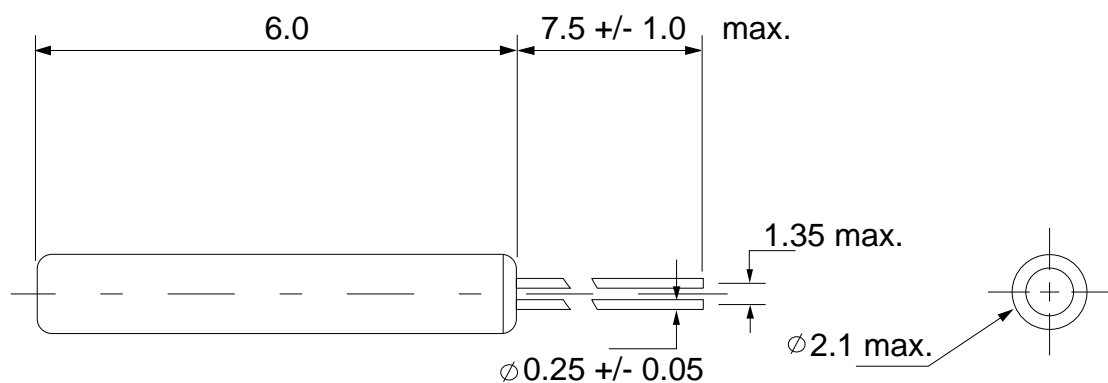

Prepared By: Leo Wong

DOC. No: DT26-32.768kHz12.5pF20ppmF_30k Ohm

MEC

REVIEW OF SPECIFICATIONS

- 1) When something get doubtful with this specifications, we shall jointly work to get an agreement.
- 2) This specification limits the quality of the components as a single unit. Please insure the component is thoroughly evaluated in your application circuit.
- 3) Please do not use this component in any application that deviates from its intended use as noted within the specification. It may cause any mishaps.
- 4) Please return one of this specification after your signature of acceptance. In case of no return within 3 months from submission date. This specification should be treated as accepted.

When using our products, the following precautions should be taken.

- (1) Safety designing of apparatus or a system allowing for failures of electronic components used in the system

In general, failures will occur in electronic components at a certain probability. MOBICON HOLDINGS LTD makes every effort to improve the quality and reliability of electronic component products. However, it is impossible to completely eliminate the probability of failures. Therefore, when using MOBICON HOLDINGS LTD electronic component products, systems should be carefully designed to ensure redundancy in the event of an accident which would result in injury or death, fire, or social damage, to ensure the prevention of the spread of fire, and the prevention of faulty operation.
- (2) Quality Level of various kinds of parts, and equipment in which the parts can be utilized

Electronic components have a standard quality level unless otherwise specified.
- (3) This specifications is subject to change without notice.

The contents of this specifications are based on data which is correct as of 2002, and they may be changed without notice. If our products are used for mass-production design, please enquire consult with a member of our company's sales staff by way of precaution.
- (4) Reprinting and copying of this specifications without prior written permission from MOBICON HOLDINGS LTD are not permitted.
- (5) Industrial Property Problems

In the event any problems associated with industrial property of a third party arising as a result of the use of our products. MOBICON HOLDINGS LTD assumes no responsibility for problems other than problems directly associated with the constitution and manufacturing method of the products.



Prepared By: Leo Wong
DOC. No: Review of Spec